

**7.** Remove the hat from the pony to put on the bridle. Place the front of the bridle over the mouth of the pony with the buckle on the pony's left. Wrap the bridle over the pony's ears. Snap the end of the strap into the buckle. (ILL. 8) You can put the hat back on if you wish.

ILL. 8

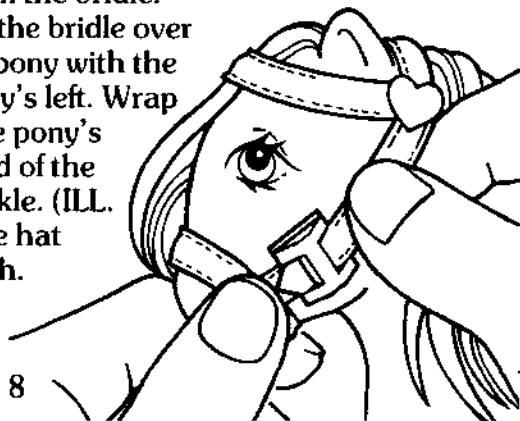

**8.** Fit the holes at the ends of the reins over the two posts in the bridle (located on each side of the pony's mouth). (ILL. 9)

ILL. 9

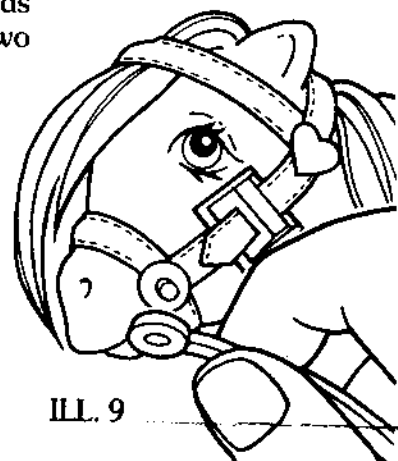

**9.** First remove the basket from the pony to put on the saddle. Place the saddle on the pony's back with the buckle on the pony's left. Wrap the buckle around and under the pony. Place the strap through the buckle until it fits into place. (ILL. 10)

ILL. 10

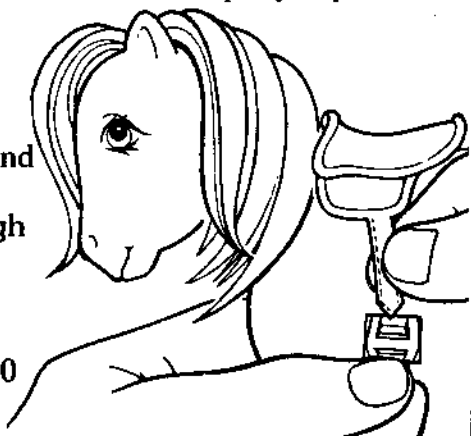

**10.** The hooks inside of the parlor are to hang your ribbons, bridle, reins, basket, etc. You can hang more than one accessory on a hook. Use the hat rack to hold your hats in place. (ILL. 11)

ILL. 11

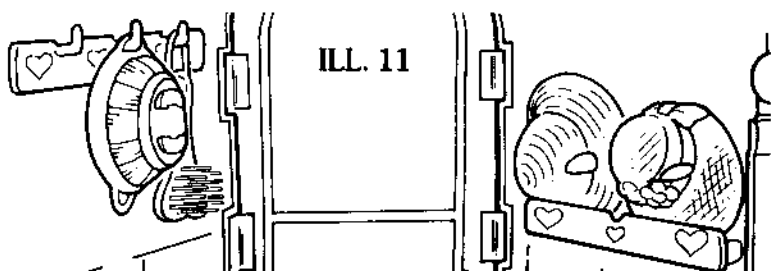

**11.** Carry Peachy (or any of your other little ponies) in the Pretty Parlor. Put her and all her accessories inside the parlor. Close the parlor by fitting the two pegs on one side into the long slot on the other side. (ILL. 12) Close and latch the front door. (ILL. 13) Carry the Pretty Parlor by the two open hearts at the top. (ILL. 14)

ILL. 12

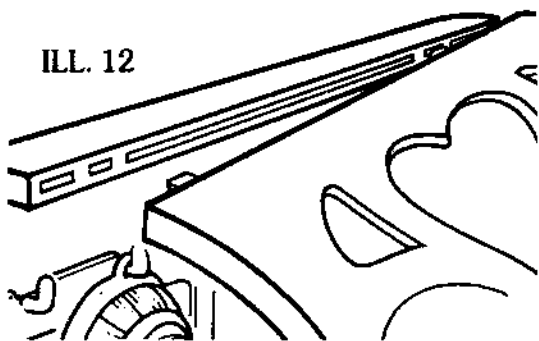

ILL. 13

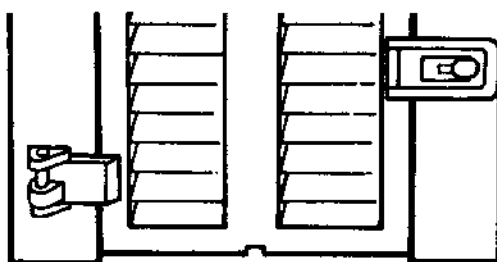

ILL. 14

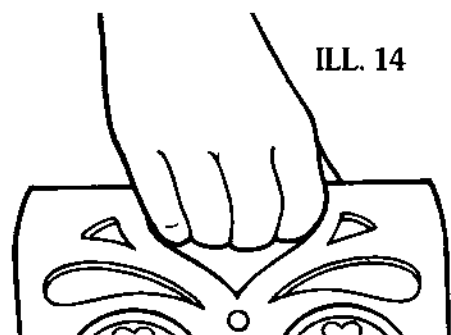

**12.** If the door happens to come off during play, firmly snap the door hinges into the hinge pins, as illustrated. (ILL. 15) If a side of the parlor comes off during play, firmly snap its tabs into the slots in the back wall of the parlor. (ILL. 16)

ILL. 15

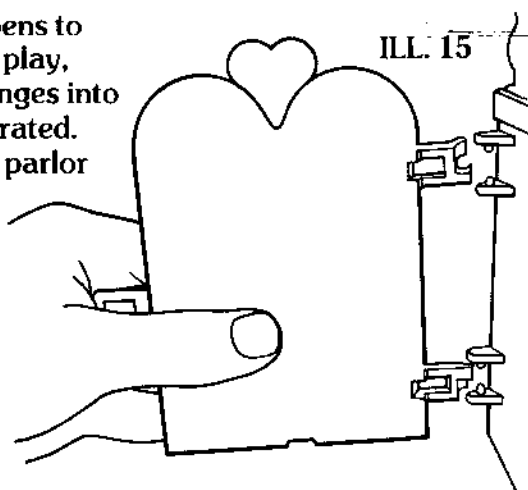

ILL. 16

