

MY LITTLE PONY™ DREAM CASTLE™ INSTRUCTIONS

1. Assemble castle by attaching wall and turret to tower as shown. (ILL. 1)

2. Peel and apply labels as indicated. (ILL. 2)

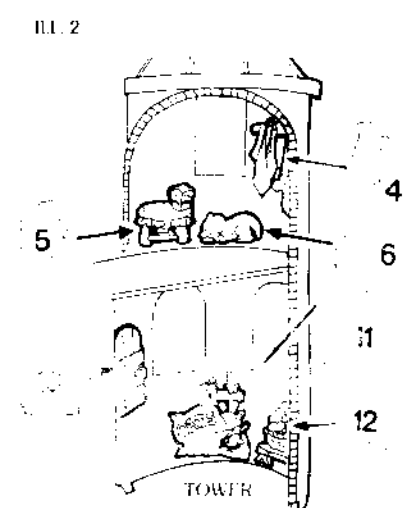
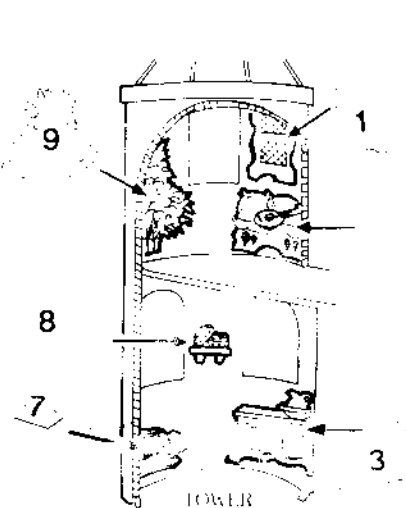
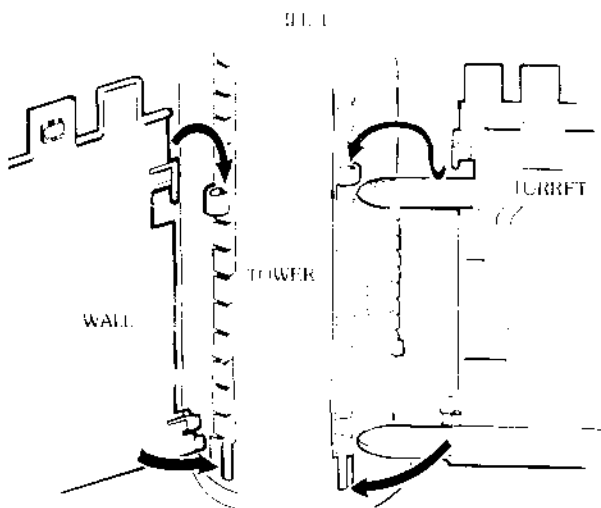

- 1. SHUTTER 2. PONY BED 3. CABINET WITH TIN AND BOWL 4. COAT RACK WITH HANGING GARMENTS
- 5. FOOTSTOOL 6. SLEEPING CAT 7. ANVIL 8. SHELF WITH SHOES 9. PLANT
- 10. KITCHEN CUPBOARD 11. OATS AND HONEY 12. BASKET OF POTATOES ON TABLE
- 13. COAT STAND 14. TREASURE CHEST 15. PORTRAIT OF SPIKE'S GRANDMA
- 16. SPIKE'S TEDDY BEAR AND BALL 17a. FRONT OF FLAG 17b. BACK OF FLAG
- 18a. FRONT OF FLAG 18b. BACK OF FLAG 19a. FRONT OF FLAG 19b. BACK OF FLAG

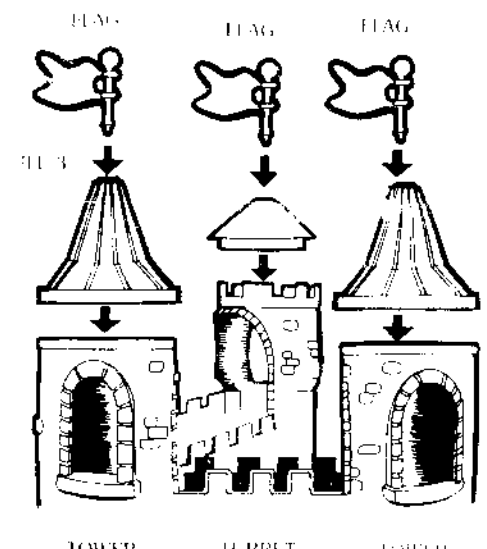
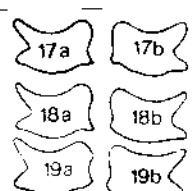
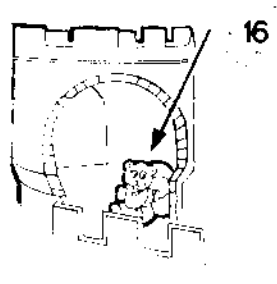
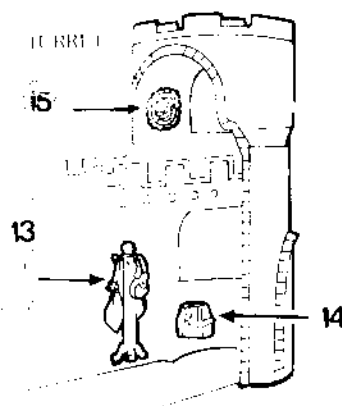

3. Place peaks on both towers and turret. Insert ring in each hole. (ILL. 3) Remove peaks for easy access to inside of castle.

4. Lower Drawbridge. Knot end of longest piece of rope. Thread through holes in winch (attached to floor upper floor and drawbridge doors) as shown. After threading through drawbridge, tie knot to other end. (ILL. 4)

5. Spike the Dragon likes to ride in his basket. Pop out hook and winch from floor. The end at end of shortest piece of rope. Thread through holes in winch and hook. (ILL. 5) Tie knot at end of rope.

6. Fit winch into holder. (ILL. 6) Snap handle onto basket. (ILL. 7) Hang basket on hook. Turn crank to move basket up and down. (ILL. 8)

